

Elevation No 1
Datum Line : 59.00m

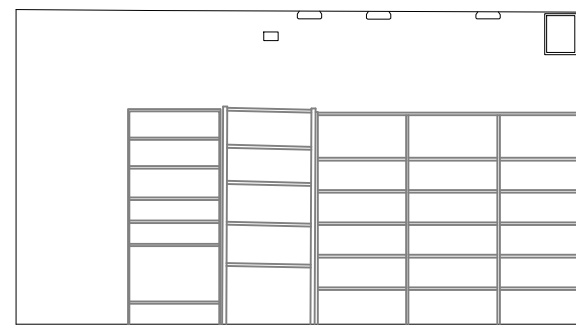

Elevation No 2
Datum Line : 59.00m

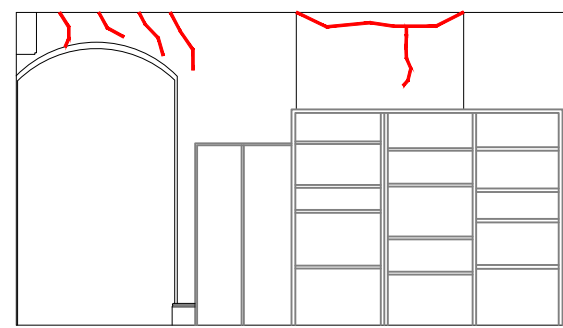

Elevation No 3
Datum Line : 59.00m

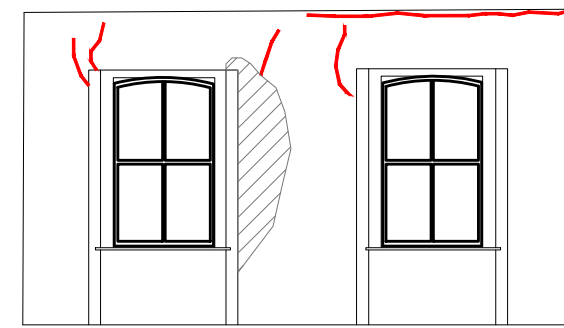

Elevation No 4
Datum Line : 59.00m

ROOM 1, 1:75

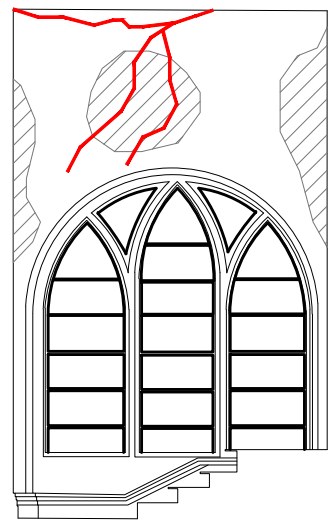

Elevation No 1
Datum Line : 57.00m

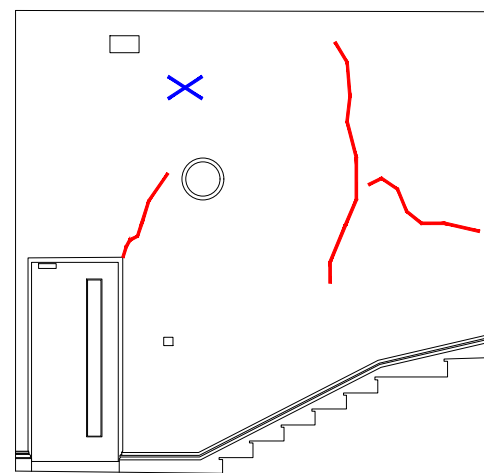

Elevation No 2
Datum Line : 57.00m

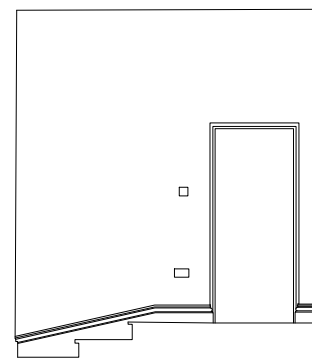

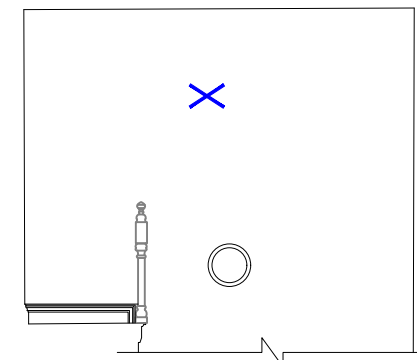

Elevation No 3
Datum Line : 58.00m



Elevation No 4
Datum Line : 58.00m

ROOM 2, 1:75

KEY

-  DAMP, FLAKING PLASTER AND PAINT
-  CRACKS
-  PLASTER IS BOAST

NOTES:
ALL DIMENSIONS TO BE CHECKED ON SITE.

DO NOT SCALE FROM DRAWING.

DISCREPANCIES AND OMISSIONS TO BE REPORTED IMMEDIATELY TO CARRIG CONSERVATION INTERNATIONAL.

THIS DRAWING IS COPYRIGHT AND IS ISSUED ON THE CONDITION THAT IT IS NOT COPIED EITHER WHOLLY OR IN PART WITHOUT THE CONSENT IN WRITING OF CARRIG CONSERVATION INTERNATIONAL.

CARRIG
conservation international

Second Floor - Atlantis Building South Cumberland Street phone: 01 353 1 5529080 e-mail: info@carrig.ie www.carrig.ie DRAWING COPYRIGHT - CARRIG CONSERVATION INTERNATIONAL			
CLIENT	Carr Cotter & Naessens Architects		
PROJECT TITLE	Carlow Library		
DRAWING TITLE	Second Floor		
DRAWING STATUS	Internal Condition Drawings		

DATE	SCALE	PAGE	REVISION
28.07.2020	1:75@A3		R00
PROJECT NUMBER	DRAWING NUMBER		
020024	C05		